

CHAMBERLAIN®

LiftMaster®

PROFESSIONAL

Model 372LM Security+® 2-Button Remote Control

The 372LM remote control can activate two separate 315MHz residential or commercial garage door openers and/or gate openers. The instructions for programming garage door openers are illustrated below. Please refer to the original receiver programming for commercial and gate products.

Both push buttons are factory programmed to work with 315MHz Security+® receivers having a purple “learn” button. The rolling code between these buttons and the receiver changes with each use, randomly accessing over 100 billion new codes.

As an added feature, the push button on the right is capable of learning or being trained to duplicate or match another CGI manufactured fixed code or billion-code remote. This feature is normally used when several remotes are required to operate one fixed code device such as a gate opener or commercial dock door. In this case, the code transmitted to the receiver remains constant or fixed, not using the Security+® format.

NOTE: The push button on the left cannot be changed from Security+®, only the right button is trainable.

⚠ WARNING

To prevent possible **SERIOUS INJURY** or **DEATH** from a moving gate or garage door:

- ALWAYS keep remote controls out of reach of children. NEVER permit children to operate, or play with remote control transmitters.
- Activate gate or door ONLY when it can be seen clearly, is properly adjusted, and there are no obstructions to door travel.
- ALWAYS keep gate or garage door in sight until completely closed. NEVER permit anyone to cross path of moving gate or door.

NOTICE: To comply with FCC and or Industry Canada rules (IC), adjustment or modifications of this receiver and/or transmitter are prohibited, except for changing the code setting or replacing the battery. THERE ARE NO OTHER USER SERVICEABLE PARTS.

Tested to Comply with FCC Standards FOR HOME OR OFFICE USE. Operation is subject to the following two conditions: (1) this device may not cause harmful interference, and (2) this device must accept any interference received, including interference that may cause undesired operation.

Figure 1

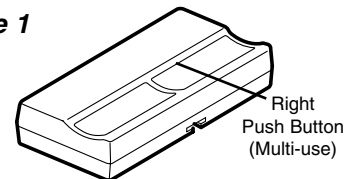

Instructions are described and illustrated below.

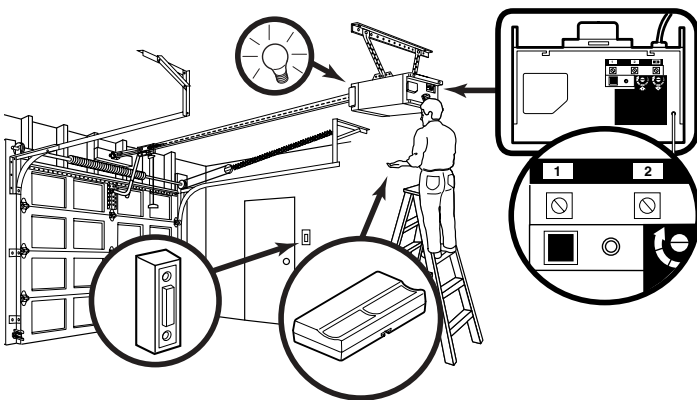

1. Press and release the “learn” button on the motor unit. The learn indicator light will glow steadily for 30 seconds.

2. Within 30 seconds, press and hold the button on the hand-held remote that you wish to operate your garage door.

3. Release the button when the motor unit light blink. It has learned the code. If light bulbs are not installed, two clicks will be heard.

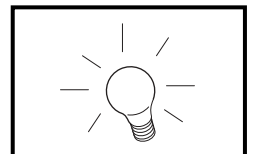
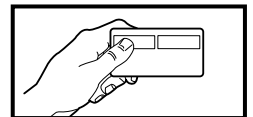
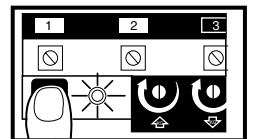

To Erase All Codes From Motor Unit Memory

To deactivate any unwanted remote, first erase all codes:

Press and the hold “learn” button on motor unit until the learn indicator light goes out (approximately 6 seconds). All previous codes are now erased. Reprogram each remote or keyless entry you wish to use.

When Several Remotes operate one device:

To match the 372LM to another 315MHz CGI manufactured remote's code (Remote Control X):

1. Begin by having both the 372LM and Remote Control X available.
2. Press and hold both buttons on the 372LM until the yellow indicator light, visible on the bottom through a small hole, begins to blink. It will blink for 30 seconds; during this time it is in the learn or training mode, and the buttons can be released.
3. While it is in learn mode, hold Remote Control X, another CGI fixed or billion-code transmitter, back to back with FCC labels touching as illustrated.
4. Press and hold the Remote Control X push button as you slowly slide the remotes across each other until the 372LM indicator light blinks very rapidly, indicating it has learned the code. (If Remote Control X is also a 372LM, you must press and hold its **right** push button.)
5. The right button is now sending the same identical coded signal as Remote Control X. This code will remain inside the 372LM until replaced with another new code by repeating steps 1-4 above, or by resetting to Security+®.

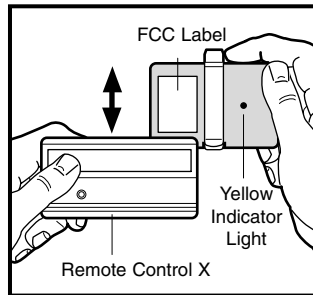
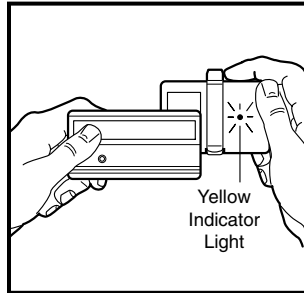
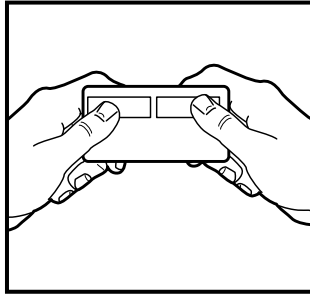

Resetting the right push button back to Security+® as follows.

Push and hold both buttons while observing the small yellow indicator light. Hold both buttons for ten seconds until the yellow indicator light stops blinking. The remote has defaulted to one of six randomly preprogrammed Security+® settings.

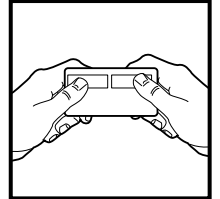

The Remote Control Batteries

⚠ WARNING

- To prevent possible SERIOUS INJURY or DEATH:
- NEVER allow small children near batteries.
 - If battery is swallowed, immediately notify doctor.

The lithium batteries should produce power for up to 5 years. To replace, pry open case with visor clip or screwdriver, as shown. Insert batteries *positive side up (+)*.

Dispose of old batteries properly.

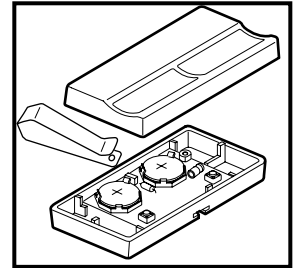

Replacement Parts

- 3V2032 Lithium battery (2 required)10A20
- Visor clip29B137

**FOR SERVICE DIAL OUR TOLL FREE NUMBER:
US: 1-800-528-2817
CANADA: 1-800-654-4736**