

CHAMBERLAIN®

Keyless Entry System Models 40 and 65

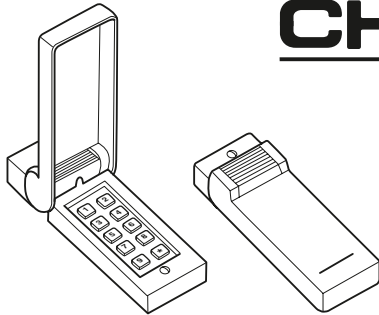

KEYBOARD

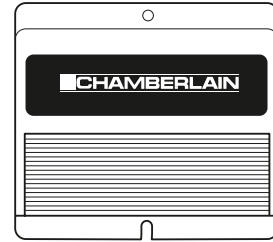

CONSOLE

The Keyless Entry System consists of a keyboard and a console. The keyboard sends a coded signal from outside the garage. The console fastens to an inside garage wall. It receives the 4-digit programmed coded signal and starts the door opener.

The Keyless Entry System will work with most Genie "Push Twice to Operate" openers if you press any other digit after you enter the 4-digit programmed code.

NOTE: Cable connector hole is located on left side of console. If possible, install keyless entry system on left side of garage (determined by facing garage from outside). If installed on right side of garage, cable must be routed over or under console.

FEATURES OF THE OF KEYLESS ENTRY SYSTEM

Personalized Code: 10,000 possible combinations. Code can be changed easily if desired.

Operation: Opener activates when programmed code is entered on the keyboard.

The user has 10 seconds from the time the first number is pressed to enter the 4-digit code.

If incorrect numbers are accidentally pressed, a 5 second interval is necessary before starting over.

Power Supply: Operates from the garage door opener power with a battery back-up for code memory and lighted keyboard. Unit will not operate without battery.

Installation: Simple to Install in 5 easy steps.

Console: Provides an additional push button control to operate door from inside garage.

Keyboard: The garage door can be operated after a valid code entry by pressing **ANY** single key **AS LONG AS THE KEYBOARD LIGHT REMAINS ON.**

Keyboard Illuminates and remains lit for 10 seconds when **ANY** number is pressed. In darkness this feature allows user to press **ANY** number before entering the 4-digit code.

IMPORTANT NOTE: When Illumination is needed, avoid pressing keyboard area which contains the first code number.



DISCONNECT THE POWER TO THE GARAGE DOOR OPENER BEFORE BEGINNING INSTALLATION.

STEP 1—SECTIONAL DOORS: Draw two intersecting lines on garage jamb face - horizontally at eye level and vertically as close to centerline as possible. **Make sure there is at least 1-1/4" clearance on each side of the vertical line.** Drill a 1" diameter hole through the jamb at marked location.

Refer to Illustration on Side 2 if your garage has a built-up jamb.

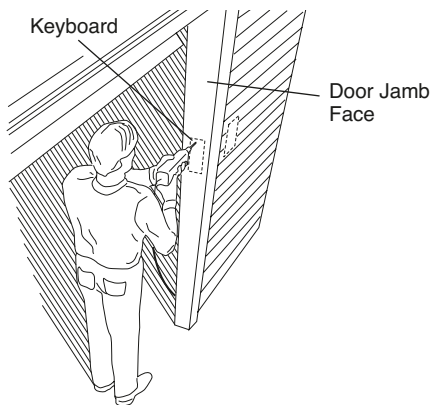

STEP 1—ONE-PIECE DOORS: Install the keyboard on the exterior front wall of a FRAME garage. Position it away from the door opening to avoid injury as door swings out and up. Drill a 1" diameter hole through wall at eye level. Refer to note below; then proceed to Step 2.

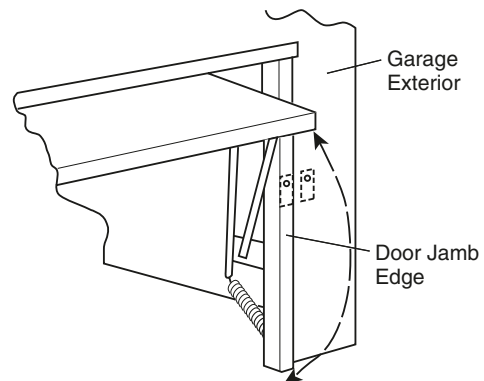

NOTE: If garage is constructed of material other than wood (brick, stone or aluminum siding), install keyboard on door jamb with this important exception: **LOCATE KEYBOARD ON OUTSIDE EDGE OF DOOR JAMB TO AVOID INJURY AS DOOR SWINGS OUT AND UP.**

PARTS LIST

Console Assembly.....	41D2995
Keyboard Assembly.....	41D2994
9 Volt Battery.....	10A15
2 Strand Bell Wire.....	219A276
Transformer Kit (inc. bell wire).....	Model 95

NO USER SERVICEABLE PARTS.
For service information call Toll Free:
1-800-528-2817

NOTE: If your garage has a built up jamb, drill the hole 2" deep. Then, on inside edge of jamb, drill a second hole into first hole to complete access.

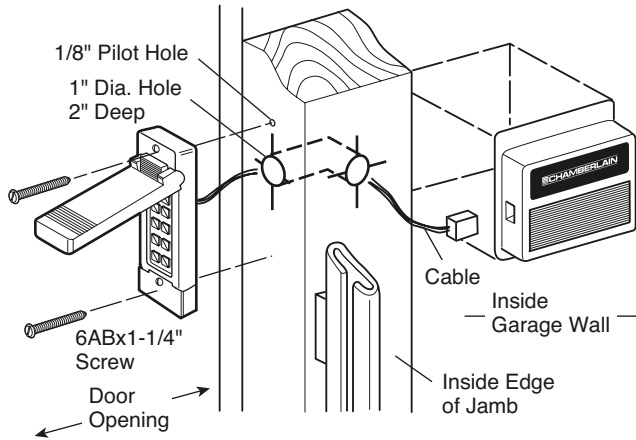

STEP 2: Hold keyboard firmly with the back of the case UP. Position thumb against bottom of case and pull up sharply. Keyboard will lift out of cover, allowing access to bottom mounting hole.

Guide the keyboard cable through hole to inside the garage. Position the keyboard against outside jamb. Drill two 1/8" pilot holes for fastening screws. Attach securely with (2) 6ABx1-1/4" screws. Close cover.

Excess cable can be folded and inserted into the access hole to keep it out of the way.

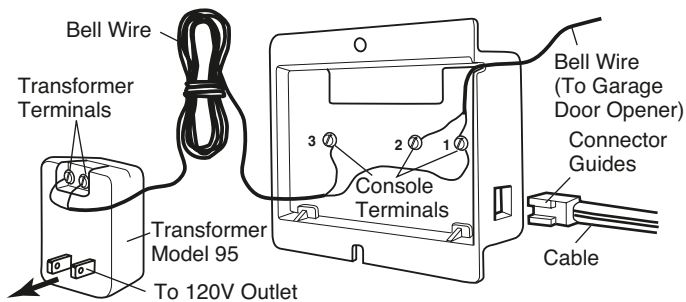

STEP 3: Connect the 2-strand bell wire to terminals labeled 1 and 2 on back of console. Insert keyboard cable connector into slot on side of console. **Be sure connector guides are facing BACK of console.**

IMPORTANT: Some garage door openers have a third screw terminal which supplies power to the radio control. This terminal can be connected to terminal No. 3 on the console with a third strand of bell wire (not supplied).

With any garage door opener made by Stanley, accessory Transformer 95 MUST be installed.

TRANSFORMER INSTALLATION INSTRUCTIONS: Connect one end of the 2-strand bell wire supplied with the kit to each of the transformer terminals (no polarity). Connect the other end of bell wire to terminals 1 and 3 on the Keyless Entry console.

IF THIS ACCESSORY IS USED WITH ANY GARAGE DOOR OPENER OTHER THAN SEARS OR CHAMBERLAIN AND THE BATTERY FAILS IN TWO MONTHS, TRANSFORMER MUST BE INSTALLED. Follow Instructions above.

STEP 4: Position console on an interior garage wall approximately one foot from outside edge of door. Fasten with (2) screws provided. Run bell wire up wall and across ceiling to garage door opener terminals. Use insulated staples to secure wire. On current line Chamberlain models, connect wire to red and white opener terminals. On older models, connect to terminals used for push button controls. Cut off any excess wire. Connect to terminals used for push button controls.

STEP 5: Pry open front panel of console with a coin or screwdriver. Snap a 9 volt battery onto circuit board connector and drop into console. **DO NOT** replace panel at this time.

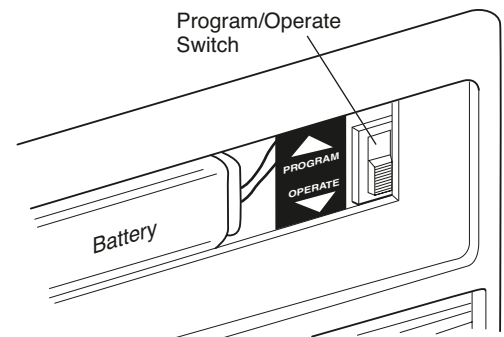
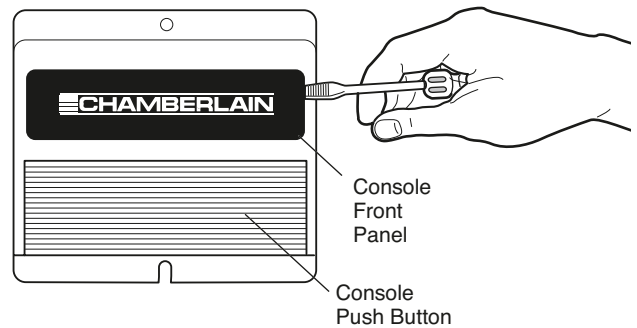

STEP 6: To set code, move program/operate switch near the battery to PROGRAM position (keyboard light should flash).

NOTE: If the light does not flash, check the cable and battery connections. Press any four numbers on keyboard. **CAUTION:** For security, do not use address, license or consecutive numbers (1,2,3,4 etc.).

Move the program/operate switch to OPERATE position (the keyboard light will go off).

Reconnect power to garage door opener. **If you have Installed Transformer Model 95, plug the transformer into a 120 VOLT outlet.** Enter the code on the keyboard. If the door operates properly, replace the front panel on the console.

Loss of power to either the battery or the garage door opener will not affect the programmed code. However, if BOTH lose power, the code must be reset.

Battery should produce adequate power for at least one year.

If light in keyboard does not turn on, change the battery.

NOTE: To maintain the privacy of your code, keep all of the buttons free from soil. If any of the numbers show signs of wear, change your code.